

PROJECT	_____
TYPE	_____
SPECIFIER	_____
QUANTITY	_____
DATE	_____

MEDIO RECESSED

E91043- _____ - _____

base number Color Lens
 Temperature Options

- To build a product code in our configurator select the specify button on the base model # product page
- To build a manual product code on this datasheet choose from the options listed below in blue font and add the suffix to the base model #

GENERAL

Series: Medio
 Subseries: Medio
 Brand: Platek
 Division: Exterior
 Mounting Type: Recessed
 Mounting Location: In-Ground
 Subcategory: Drive Over

PHYSICAL

Shape: Round
 Diameter (mm): 206
 Diameter (in): 8 1/16
 Height (mm): 230
 Height (in): 9 1/16
 Light Distribution: Uplight
 Weight (kg): 3.5
 Weight (lbs): 7.72
 Load Resistance (kg): 2000
 Load Resistance (lbs): 4409
 Installation Requirement: Installation in sleeve set in concrete with a 20-30 cm gravel drain bed
 Screws: A4 stainless steel
 Diffuser: Clear tempered glass
 Fixture Finish: BLK
 Fixture Material: Aluminum Die Cast

ELECTRICAL

Lamp Type: LED
 Input Wattage (W): 20
 Total Output Wattage (W): 17
 Dimming: Non-Dimming / Phase Dimming (120vac Only)
 Driver Included: Yes
 Driver Location: Integrated
 Driver Type: Constant Current - Universal
 Driver Class: Class 2
 Input Voltage (V): 120 - 277
 Constant Current (MA): 500
 Upon Request: (Not included - see components [IP65 or higher enclosure, to be supplied by others]) Remote: 0-10Vdc dimming

LED

Number of LEDs: 1
 Color Temperature (°K): 3000 / 4000
 Max. Delivered Lumen (lm): 1570 - 1650
 Nominal Lumen (lm): 2400 / 3200
 CRI: >80 CRI
 Lamp Life (hrs): 60000

OPTICAL

Optic°: 13 / 44

RATINGS AND CERTIFICATIONS

Certified By: Certified for North American Standards
 IP rating: IP68
 IK Rating: IK10



Ø214mm 8 7/16"

Ø153mm 6"



230mm 9 1/16"

260mm 10 1/4"



MEDIO RECESSED

E91043-

PROJECT	_____
TYPE	_____
SPECIFIER	_____
QUANTITY	_____
DATE	_____



...



PROJECT	_____
TYPE	_____
SPECIFIER	_____
QUANTITY	_____
DATE	_____

MEDIO SS RECESSED

E91083- _____ - _____
 base number Color Lens
 Temperature Options

- To build a product code in our configurator select the specify button on the base model # product page
- To build a manual product code on this datasheet choose from the options listed below in blue font and add the suffix to the base model #

GENERAL

Series: Medio
 Subseries: Medio SS
 Brand: Platek
 Division: Exterior
 Mounting Type: Recessed
 Mounting Location: In-Ground
 Subcategory: Drive Over

PHYSICAL

Shape: Round
 Diameter (mm): 224
 Diameter (in): 8 3/4
 Height (mm): 230
 Height (in): 9 1/16
 Light Distribution: Uplight
 Weight (kg): 3.8
 Weight (lbs): 8.38
 Load Resistance (kg): 2000
 Load Resistance (lbs): 4409
 Installation Requirement: Installation in sleeve set in concrete with a 20-30 cm gravel drain bed
 Screws: A4 stainless steel
 Diffuser: Clear tempered glass
 Fixture Finish: SST
 Fixture Material: Aluminum Die Cast

ELECTRICAL

Lamp Type: LED
 Input Wattage (W): 20
 Total Output Wattage (W): 17
 Dimming: Non-Dimming / Phase Dimming (120vac Only)
 Driver Included: Yes
 Driver Location: Integrated
 Driver Type: Constant Current - Universal
 Driver Class: Class 2
 Input Voltage (V): 120 - 277
 Constant Current (MA): 500
 Upon Request: (Not included - see components [IP65 or higher enclosure, to be supplied by others]) Remote: 0-10Vdc dimming

LED

Number of LEDs: 1
 Color Temperature (°K): 3000 / 4000
 Max. Delivered Lumen (lm): 1570 - 1650
 Nominal Lumen (lm): 2400 / 3200
 CRI: >80 CRI
 Lamp Life (hrs): 60000

OPTICAL

Optic°: 18 / 44

RATINGS AND CERTIFICATIONS

Certified By: Certified for North American Standards
 IP rating: IP68
 IK Rating: IK10



Ø224mm 8 13/16"

Ø153mm 6"

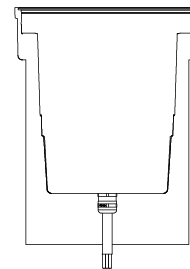
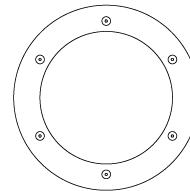

230mm 9 1/16"

260mm 10 1/4"



MEDIO SS RECESSED

E91083-

PROJECT	_____
TYPE	_____
SPECIFIER	_____
QUANTITY	_____
DATE	_____



E

MEDIO RECESSED

E91278-

base number Color Lens
Temperature Options

PROJECT
TYPE
SPECIFIER
QUANTITY
DATE

- To build a product code in our configurator select the specify button on the base model # product page
- To build a manual product code on this datasheet choose from the options listed below in blue font and add the suffix to the base model #

GENERAL

Series: Medio
Subseries: Medio
Brand: Platek
Division: Exterior
Mounting Type: Recessed
Mounting Location: In-Ground
Subcategory: Drive Over

PHYSICAL

Shape: Round
Diameter (mm): 206
Diameter (in): 8 1/8
Height (mm): 230
Height (in): 9 1/16
Light Distribution: Uplight
Weight (kg): 3.3
Weight (lbs): 7.3
Load Resistance (kg): 2000
Load Resistance (lbs): 4409
Installation Requirement: Installation in sleeve set in concrete with a 20-30 cm gravel drain bed
Screws: A4 stainless steel
Diffuser: Clear tempered glass
Fixture Finish: BLK
Fixture Material: Aluminum Die Cast
Cable Details: Supplied with 1 power cable 1.5m in length

ELECTRICAL

Lamp Type: LED
Input Wattage (W): 21
Total Output Wattage (W): 18.5
Dimming: Non-Dimming / Phase Dimming (120vac Only)
Driver Included: Yes
Driver Location: Integrated
Driver Type: Constant Current - Universal
Driver Class: Class 2
Input Voltage (V): 120 - 277
Constant Current (MA): 700
Upon Request: (Not included - see components [IP65 or higher enclosure to be supplied by others]) Remote: 0-10Vdc dimming

LED

Number of LEDs: 9
Color Temperature (°K): 3000 / 4000
Max. Delivered Lumen (lm): 1440 - 2080
CRI: >80 CRI
Lamp Life (hrs): 60000

OPTICAL

Optic: 9 / 28 / 45 / Asy
Beam Angle: Spot / Medium / Wide / Asymmetrical
Adjustability: Tilt 15°

RATINGS AND CERTIFICATIONS

Certified By: Certified for North American Standards
IP rating: IP68
IK Rating: IK10



Ø214mm 8 7/16"

Ø153mm 6"

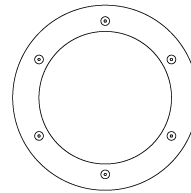

230mm 9 1/16"

260mm 10 1/4"



MEDIO RECESSED

E91278-

PROJECT	_____
TYPE	_____
SPECIFIER	_____
QUANTITY	_____
DATE	_____



...



MEDIO SS RECESSED

E91302- _____ - _____

base number Color Lens
 Temperature Options

PROJECT
TYPE
SPECIFIER
QUANTITY
DATE

- To build a product code in our configurator select the specify button on the base model # product page
- To build a manual product code on this datasheet choose from the options listed below in blue font and add the suffix to the base model #

GENERAL

Series: Medio
 Subseries: Medio SS
 Brand: Platek
 Division: Exterior
 Mounting Type: Recessed
 Mounting Location: In-Ground
 Subcategory: Drive Over

PHYSICAL

Shape: Round
 Diameter (mm): 224
 Diameter (in): 8 ¹³/₁₆
 Height (mm): 230
 Height (in): 9 ¹/₁₆
 Light Distribution: Uplight
 Weight (kg): 4.4
 Weight (lbs): 9.7
 Load Resistance (kg): 2000
 Load Resistance (lbs): 4409
 Installation Requirement: Installation in sleeve set in concrete with a 20-30 cm gravel drain bed
 Screws: A4 stainless steel
 Diffuser: Clear tempered glass
 Fixture Finish: SST
 Fixture Material: Aluminum Die Cast
 Cable Details: Supplied with 1 power cable 1.5m in length

ELECTRICAL

Lamp Type: LED
 Input Wattage (W): 22
 Total Output Wattage (W): 19
 Dimming: Non-Dimming / Phase Dimming (120vac Only)
 Driver Included: Yes
 Driver Location: Integrated
 Driver Type: Constant Current - Universal
 Driver Class: Class 2
 Input Voltage (V): 120 - 277
 Constant Current (MA): 700
 Upon Request: (Not included - see components [IP65 or higher enclosure to be supplied by others]) Remote: 0-10Vdc dimming

LED

Number of LEDs: 9
 Color Temperature (°K): 3000 / 4000
 Max. Delivered Lumen (lm): 2000 - 2080
 Nominal Lumen (lm): 2250 / 2340
 CRI: >80 CRI
 Lamp Life (hrs): 60000

OPTICAL

Optic°: 9 / 28 / 45 / ASY
 Adjustability: Tilt 15°

RATINGS AND CERTIFICATIONS

Certified By: Certified for North American Standards
 IP rating: IP68
 IK Rating: IK10



Ø214mm 8 7/16"

Ø153mm 6"

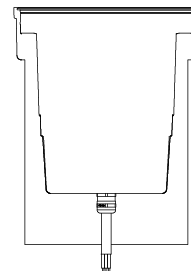
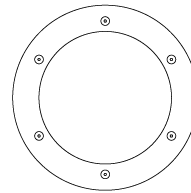

230mm 9 1/16"

260mm 10 1/4"



E9I302-

PROJECT	_____
TYPE	_____
SPECIFIER	_____
QUANTITY	_____
DATE	_____

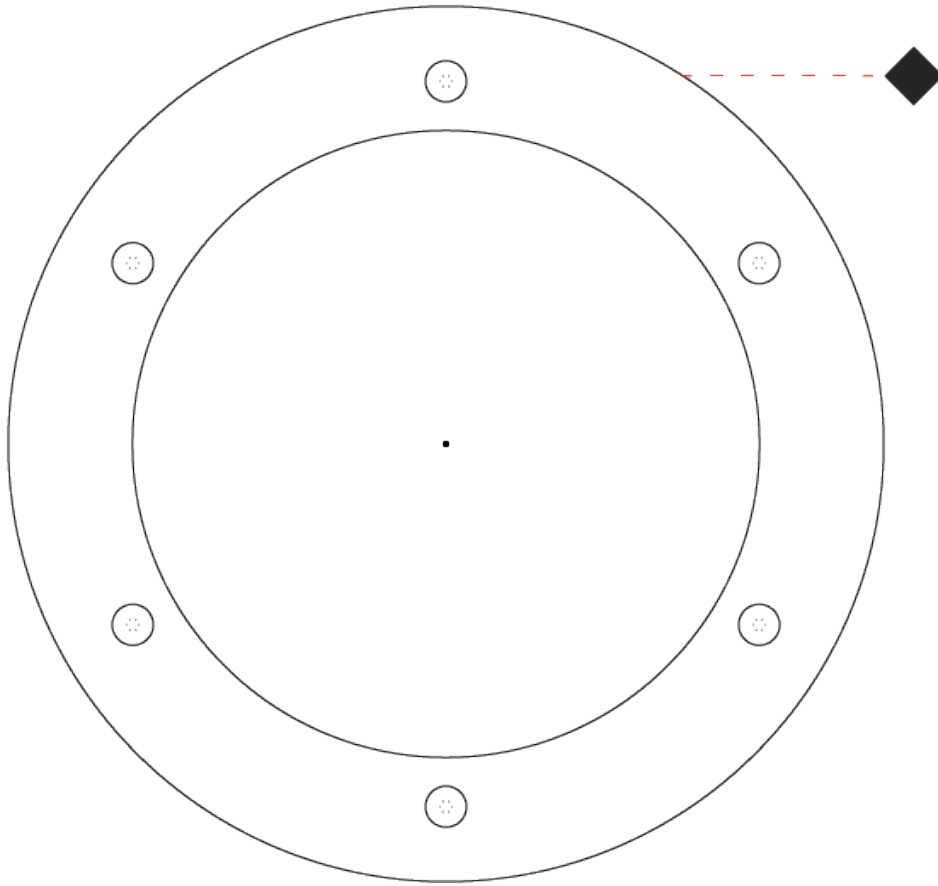

...



MEDIO RECESSED

E91478- _____ - _____

base number Color Lens
 Temperature Options

- To build a product code in our configurator select the specify button on the base model # product page
- To build a manual product code on this datasheet choose from the options listed below in blue font and add the suffix to the base model #

GENERAL

Series: Medio
 Subseries: Medio
 Brand: Platek
 Division: Exterior
 Mounting Type: Recessed
 Mounting Location: In-Ground
 Subcategory: Drive Over

PHYSICAL

Shape: Round
 Diameter (mm): 206
 Diameter (in): 8 1/8
 Height (mm): 230
 Height (in): 9 1/16
 Light Distribution: Uplight
 Weight (kg): 3.5
 Weight (lbs): 7.72
 Load Resistance (kg): 2000
 Load Resistance (lbs): 4409
 Installation Requirement: Installation in sleeve set in concrete with a 20-30 cm gravel drain bed
 Screws: A4 stainless steel
 Diffuser: Flat Tempered Glass - 12mm / 15/32"
 Fixture Finish: BLK
 Fixture Material: Aluminum Die Cast

ELECTRICAL

Lamp Type: LED
 Input Wattage (W): 27
 Total Output Wattage (W): 24
 Dimming: Non-Dimming / Phase Dimming (120vac Only)
 Driver Included: Yes
 Driver Location: Integrated
 Driver Type: Constant Current - Universal
 Driver Class: Class 2
 Input Voltage (V): 120 - 277
 Constant Current (MA): 700
 Upon Request: (Not included - see components [IP65 or higher enclosure to be supplied by others]) Remote: 0-10Vdc dimming

LED

Number of LEDs: 1
 Color Temperature (°K): 3000 / 4000
 Max. Delivered Lumen (lm): 3090 / 3130 - 3215 / 3255
 CRI: >80 CRI
 Lamp Life (hrs): 60000

OPTICAL

Optic°: 18 / 44

RATINGS AND CERTIFICATIONS

Certified By: Certified for North American Standards
 IP rating: IP68
 IK Rating: IK10



Ø214mm 8 7/16"

Ø153mm 6"

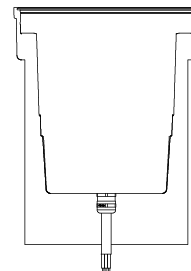
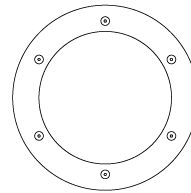

230mm 9 1/16"

260mm 10 1/4"



MEDIO RECESSED

E9I478-

PROJECT	_____
TYPE	_____
SPECIFIER	_____
QUANTITY	_____
DATE	_____



...



MEDIO SS RECESSED

E91486- _____ - _____

base number Color Lens
 Temperature Options

PROJECT
TYPE
SPECIFIER
QUANTITY
DATE

- To build a product code in our configurator select the specify button on the base model # product page
- To build a manual product code on this datasheet choose from the options listed below in blue font and add the suffix to the base model #

GENERAL

Series: Medio
 Subseries: Medio SS
 Brand: Platek
 Division: Exterior
 Mounting Type: Recessed
 Mounting Location: In-Ground
 Subcategory: Drive Over

PHYSICAL

Shape: Round
 Diameter (mm): 224
 Diameter (in): 8 ¹³/₁₆
 Height (mm): 230
 Height (in): 9 ¹/₁₆
 Light Distribution: Uplight
 Weight (kg): 3.8
 Weight (lbs): 8.38
 Load Resistance (kg): 2000
 Load Resistance (lbs): 4409
 Installation Requirement: Installation in sleeve set in concrete with a 20-30 cm gravel drain bed
 Diffuser: Extra Clear Tempered Glass - 15 mm / 9/16" thick
 Fixture Finish: SST
 Fixture Material: Aluminum Die Cast

ELECTRICAL

Lamp Type: LED
 Input Wattage (W): 27
 Total Output Wattage (W): 24
 Dimming: Non-Dimming / Phase Dimming (120vac Only)
 Driver Included: Yes
 Driver Location: Integrated
 Driver Type: Constant Current - Universal
 Driver Class: Class 2
 Input Voltage (V): 120 - 277
 Constant Current (MA): 700
 Upon Request: (Not included - see components [IP65 or higher enclosure to be supplied by others]) Remote: 0-10Vdc dimming

LED

Color Temperature (°K): 3000 / 4000
 Max. Delivered Lumen (lm): 3090 / 3130 - 3215 / 3255
 CRI: >80 CRI
 Lamp Life (hrs): 60000

OPTICAL

Optic°: 18 / 44

RATINGS AND CERTIFICATIONS

Certified By: Certified for North American Standards
 IP rating: IP68
 IK Rating: IK10



Ø224mm 8 ¹³/₁₆"

Ø153mm 6"

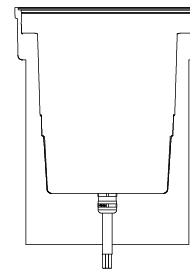
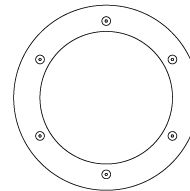

230mm 9 ¹/₁₆"

260mm 10 ¹/₄"



E91486-

PROJECT	_____
TYPE	_____
SPECIFIER	_____
QUANTITY	_____
DATE	_____



E

PROJECT	_____
TYPE	_____
SPECIFIER	_____
QUANTITY	_____
DATE	_____

MEDIO MARINE GRADE RECESSED

E9I588- _____ - _____
 base number Color Lens
 Temperature Options

- To build a product code in our configurator select the specify button on the base model # product page
- To build a manual product code on this datasheet choose from the options listed below in blue font and add the suffix to the base model #

GENERAL

Series: Medio
 Subseries: Medio Marine Grade
 Brand: Platek
 Division: Exterior
 Mounting Type: Recessed
 Mounting Location: In-Ground
 Subcategory: Drive Over

PHYSICAL

Shape: Round
 Diameter (mm): 220
 Diameter (in): 8 ¹¹/₁₆
 Height (mm): 113
 Height (in): 4 ⁷/₁₆
 Light Distribution: Uplight
 Weight (kg): 3.40
 Weight (lbs): 7.5
 Load Resistance (kg): 1500
 Load Resistance (lbs): 3307
 Installation Requirement: Installation in sleeve set in concrete with a 20-30 cm gravel drain bed
 Screws: A4 stainless steel
 Diffuser: Clear tempered glass
 Fixture Finish: SST
 Fixture Material: Stainless Steel AISI 316L
 Cable Details: Supplied with 1 power cable 1m in length

ELECTRICAL

Lamp Type: LED
 Input Wattage (W): 15
 Total Output Wattage (W): 14
 Driver Included: No
 Driver Location: Remote
 Driver Type: Constant Voltage - 120 / 277Vac
 Driver Class: Class 2
 Input Voltage (V): 120 - 277
 Output Voltage (V): 24
 Upon Request: (Not included - see components [IP65 or higher enclosure to be supplied by others]) 0-10Vdc dimming / Phase dimming / Non-dimming 120/277Vac

LED

Number of LEDs: 9
 Color Temperature (°K): 3000 / 4000
 Max. Delivered Lumen (lm): 1480 / 1540
 Nominal Lumen (lm): 1710 / 1800
 CRI: >80 CRI
 Lamp Life (hrs): 60000

OPTICAL

Optic^o: 9 / 28 / 45 / ELL

RATINGS AND CERTIFICATIONS

Certified By: Certified for North American Standards
 IP rating: IP68
 IK Rating: IK10
 Marine Grade: Stainless Steel AISI 316L



220mm 8 ¹¹/₁₆"

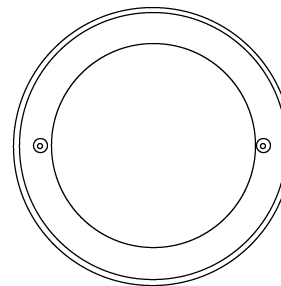

196mm 7 ¹¹/₁₆"

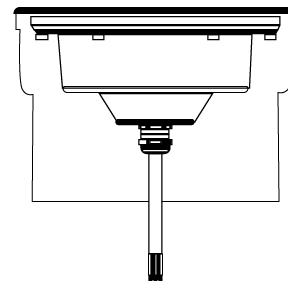

113mm 4 ⁷/₁₆"
 140mm 5 ¹/₂"



MEDIO MARINE GRADE RECESSED

E9I588-

PROJECT

TYPE

SPECIFIER

QUANTITY

DATE



MEDIO RECESSED

E91627-

base number Lens
Options

- To build a product code in our configurator select the specify button on the base model # product page
- To build a manual product code on this datasheet choose from the options listed below in blue font and add the suffix to the base model #

GENERAL

Series: Medio
Subseries: Medio
Brand: Platek
Division: Exterior
Mounting Type: Recessed
Mounting Location: In-Ground
Subcategory: Drive Over

PHYSICAL

Shape: Round
Diameter (mm): 206
Height (mm): 230
Height (in): 9 1/16
Light Distribution: Uplight
Weight (kg): 3.3
Weight (lbs): 7.3
Load Resistance (kg): 2000
Load Resistance (lbs): 4409
Installation Requirement: Installation in sleeve set in concrete with a 20-30 cm gravel drain bed
Screws: A4 stainless steel
Diffuser: Clear tempered glass
Fixture Finish: BLK
Fixture Material: Aluminum Die Cast
Cable Details: Supplied with 1 power cable 1.5m in length

ELECTRICAL

Lamp Type: LED
Input Wattage (W): 16
Total Output Wattage (W): 16
Dimming: Bluetooth technology or DMX
Control Gear: DMX
Driver Included: No
Driver Location: Remote
Driver Type: Constant Current - Universal
Driver Class: Class 2
Input Voltage (V): 120 - 277
Constant Current (MA): 350

LED

Number of LEDs: 16
Color Temperature (°K): RGBW
CRI: >80 CRI
Efficiency (%): 99.4
Lamp Life (hrs): 60000
Special LEDs offerings: RGBW

OPTICAL

Optic°: 9 / 28 / 44

RATINGS AND CERTIFICATIONS

Certified By: Certified for North American Standards
IP rating: IP68
IK Rating: IK10

PROJECT	
TYPE	
SPECIFIER	
QUANTITY	
DATE	



Ø214mm 8 7/16"

Ø153mm 6"

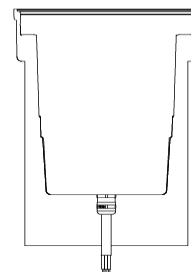
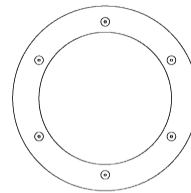

230mm 9 1/16"

260mm 10 1/4"



MEDIO RECESSED

E9I627-

PROJECT	_____
TYPE	_____
SPECIFIER	_____
QUANTITY	_____
DATE	_____

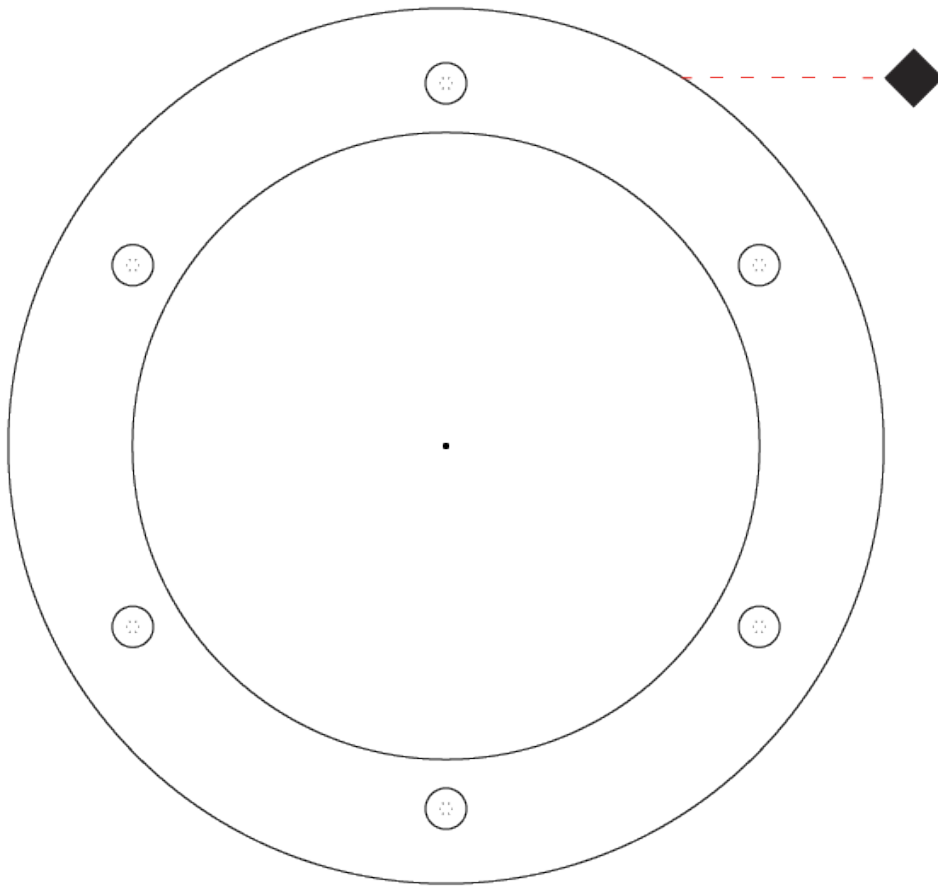

...



MEDIO MARINE GRADE RECESSED

E91629-

base number Lens
Options

- To build a product code in our configurator select the specify button on the base model # product page
- To build a manual product code on this datasheet choose from the options listed below in blue font and add the suffix to the base model #

GENERAL

Series: Medio
Subseries: Medio Marine Grade
Brand: Platek
Division: Exterior
Mounting Type: Recessed
Mounting Location: In-Ground
Subcategory: Drive Over

PHYSICAL

Shape: Round
Diameter (mm): 220
Diameter (in): 8 ¹¹/₁₆
Height (mm): 113
Height (in): 4 ⁷/₁₆
Light Distribution: Uplight
Weight (kg): 3.40
Weight (lbs): 7.5
Load Resistance (kg): 1500
Load Resistance (lbs): 3307
Installation Requirement: Installation in sleeve set in concrete with a 20-30 cm gravel drain bed
Screws: A4 stainless steel
Diffuser: Clear tempered glass
Fixture Finish: SST
Fixture Material: Stainless Steel AISI 316L
Cable Details: Supplied with 1 power cable 1m in length

ELECTRICAL

Lamp Type: LED
Input Wattage (W): 16
Total Output Wattage (W): 16
Dimming: Bluetooth technology or DMX
Control Gear: DMX
Driver Included: No
Driver Location: Remote
Driver Type: Constant Current - Universal
Driver Class: Class 2
Input Voltage (V): 120 - 277
Constant Current (MA): 350

LED

Number of LEDs: 16
Color Temperature (°K): RGBW
CRI: >80 CRI
Lamp Life (hrs): 60000
Special LEDs offerings: RGBW

OPTICAL

Optic: 9 / 28 / 45 / ELL

RATINGS AND CERTIFICATIONS

Certified By: Certified for North American Standards
IP rating: IP68
IK Rating: IK10
Marine Grade: Stainless Steel AISI 316L

PROJECT	
TYPE	
SPECIFIER	
QUANTITY	
DATE	



220mm 8 ¹¹/₁₆"

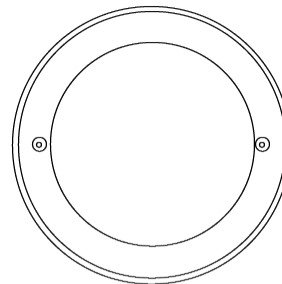

196mm 7 ¹¹/₁₆"

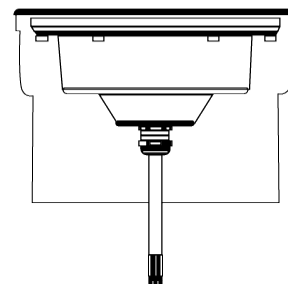

113mm 4 ⁷/₁₆"
140mm 5 ¹/₂"



MEDIO MARINE GRADE RECESSED

E9I629-

PROJECT

TYPE

SPECIFIER

QUANTITY

DATE



PROJECT

TYPE

SPECIFIER

QUANTITY

DATE

Fixture Finish

Black - BLK



Stainless Steel Inox - SST

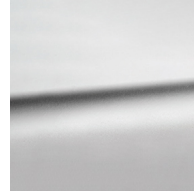

Digital: Not all screens are calibrated the same, and therefore, colors will appear differently between screens.

Physical: When texture is involved, there will be variations in color, character and tone within a product series and between product families.



PROJECT	
TYPE	
SPECIFIER	
QUANTITY	
DATE	

LEGEND

	floor-mounted		pivotal		special LED (upon request) RGB, RGBW, tunable, gold+, meat+, art+, fashion+
	wall and ceiling: recessed and surface mounted		rotating		warm dim / natural dimming LED
	ceiling-mounted and wall-mounted		illuminate tilted		rechargeable battery powered
	wall-mounted		color of suspension cable		fixture with natural vivid LED (upon request)
	omni-directional light distribution		length of suspension cable		color rendering index
	direct light distribution		reflector degree selection		color temperature
	direct/indirect light distribution		super spot		lumen (luminous flux)
	indirect light distribution		lens		efficacy (lumens per watt)
	asymmetric light distribution		lens pack		Unified Glare Rating (UGR) range from 5-40
	aura light distribution		shine ring		marine grade (AISI 316 stainless steel)
	round wall or ceiling cut-out		integrated shine ring with diffuser		walk on
	square wall or ceiling cut-out		free individual colors 01-29		drive on
	the supplied jig specifies the cutout dimensions		individual colors: 00 (free of charge), 01-25 (extra charge)		Dark Sky Compliance
	minimum distance (meters) lamp - object		luminaire part to be colored (F1)		Americans with Disabilities Act (less than 4" off the wall located between 27"-84" from floor)
	recessed depth		luminaire part to be colored (F2)		lamp protected against explosion
	ceiling thickness in mm		luminaire part to be colored (F3)		blown glass using traditional methods by master glass blower
	ceiling thickness selection		luminaire part to be colored (F4)		acoustic material
	dimmable DP (phase), DV (0-10V), DD (dali), DS (step-dim)		luminaire part to be colored (F5)		protection class I, protection insulation
	included or excluded LED driver/transformer/control gear		color of 3-circuit adaptor		protection class II, protection insulation
	separately switchable		indirect diffuser		ETL Certified to UL and CSA Standards
	sensor		direct diffuser		UL Certified to UL and CSA Standards
	remote control		ball-proof (upon request)		CSA Certified to UL and CSA Standards
	available upon request		accessory		Certified for North American Standards

IP RATING

	protected against ingress of solid bodies greater than 12.5mm (finger)
	protected against ingress of solid bodies greater than 2.5mm protected against sprays of water up to 60 degrees from the vertical (rain)
	protected against ingress of solid bodies greater than 1mm (wire) no protection against the ingress of moisture
	protected against ingress of solid bodies greater than 1mm (wire) protected against sprays of water up to 60 degrees from the vertical (rain)
	protected against ingress of solid bodies greater than 1mm (wire) protected against water splashed from all directions
	protected against limited ingress of dust (wet rooms/covered outdoor areas) protected against water splashed from all directions
	protected against ingress of dust protected against jets of water
	protected against ingress of dust protected against powerful jets of water or heavy seas
	protected against ingress of dust protected against immersion of water between 15cm - 1m for 30 minutes
	protected against ingress of dust protected against immersion of water under pressure for long periods

IK RATING

	protected against 0.14 joules impact (equivalent to 0.25kg mass dropped from 56mm above the surface)
	protected against 0.2 joules impact (equivalent to 0.25kg mass dropped from 80mm above the surface)
	protected against 0.35 joules impact (equivalent to 0.25kg mass dropped from 140mm above the surface)
	protected against 0.5 joules impact (equivalent to 0.25kg mass dropped from 200mm above the surface)
	protected against 0.7 joules impact (equivalent to 0.25kg mass dropped from 280mm above the surface)
	protected against 1 joules impact (equivalent to 0.25kg mass dropped from 400mm above the surface)
	protected against 2 joules impact (equivalent to 0.5kg mass dropped from 400mm above the surface)
	protected against 5 joules impact (equivalent to 1.7kg mass dropped from 300mm above the surface)
	protected against 10 joules impact (equivalent to 5.0kg mass dropped from 200mm above the surface)
	protected against 20 joules impact (equivalent to 5.0kg mass dropped from 400mm above the surface)